

Corner Gusset

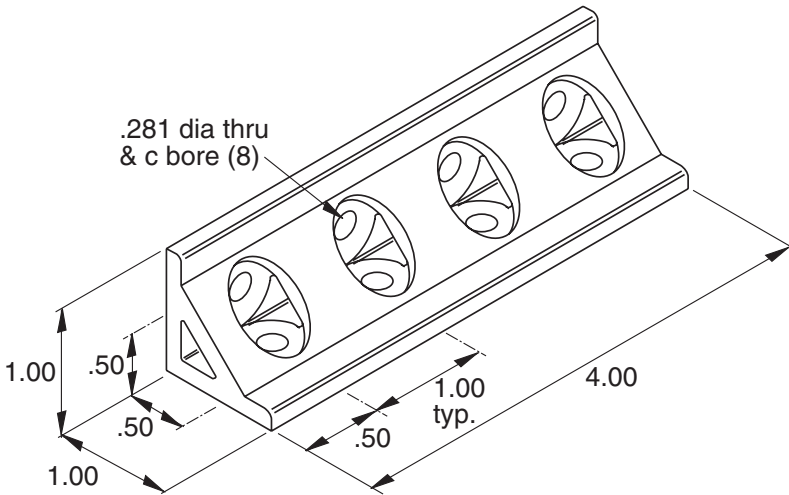

11-163



Recommended
Hardware
(8) 11-231 BHCS
(8) 11-210 T-nut

1/4" SLOTS

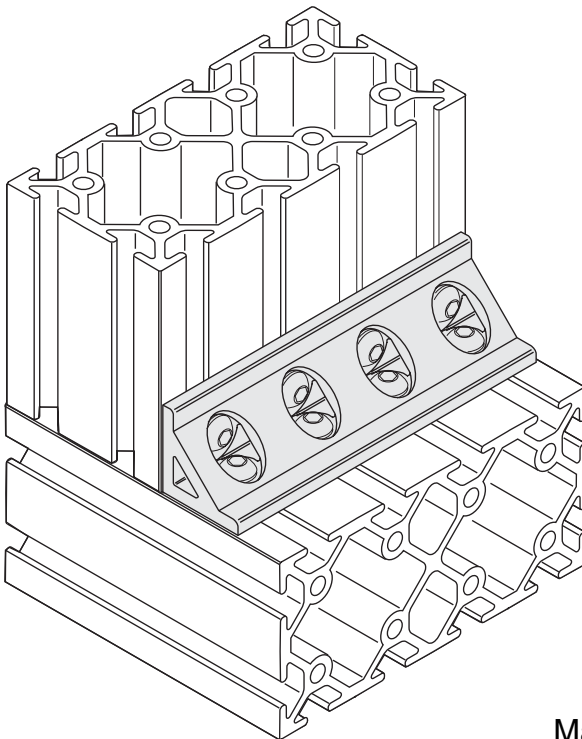

Material - Aluminum
Finish - Clear Anodize