

Recommended Hardware  
(6) 11-231 BHCS  
(6) 11-210 T-nut

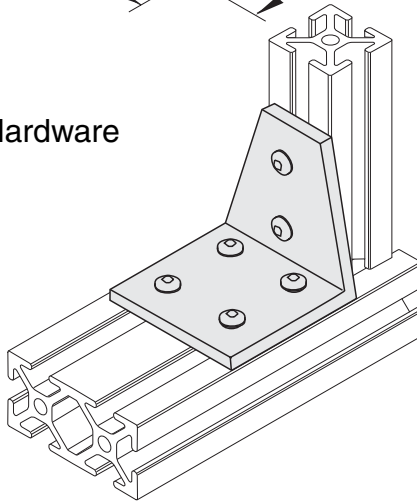

**1/4" SLOTS**

Material - Aluminum  
Finish - Clear Anodize