

**11-80**

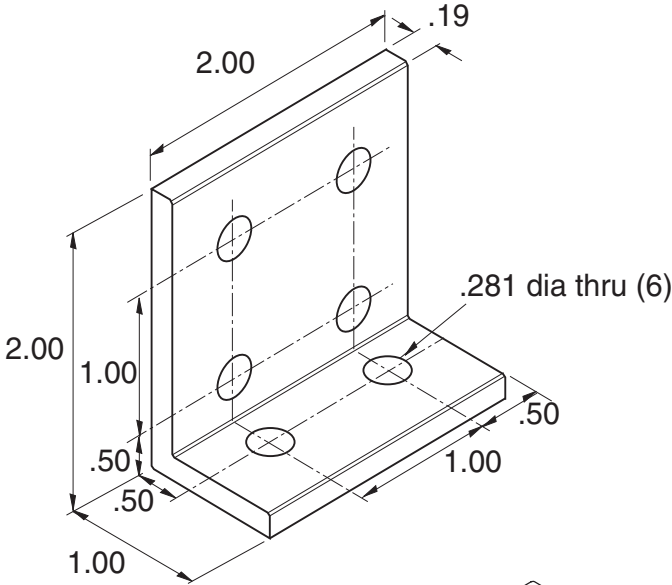

Recommended Hardware  
(6) 11-231 BHCS  
(6) 11-210 T-nut

1/4" SLOTS

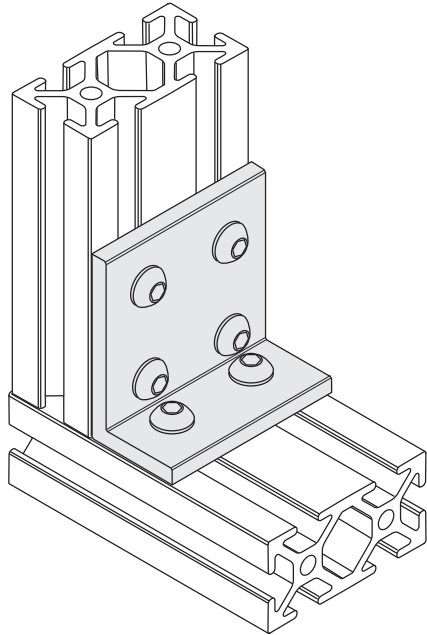

Material - Aluminum  
Finish - Clear Anodize