

# Double Mount Linear Bearing with Locking Handle

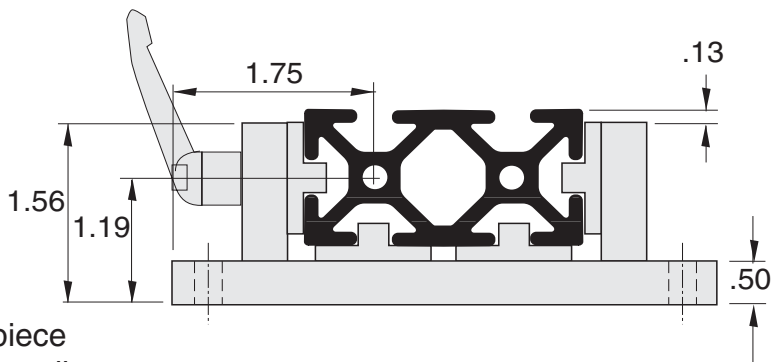

**11-95LH**



Note: 3-piece design for adjustability

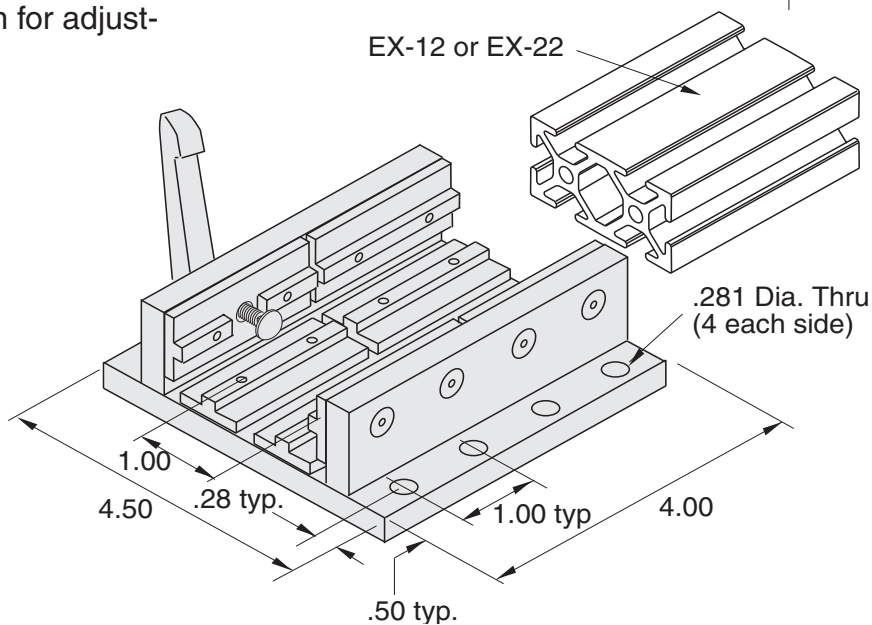

**1/4" SLOTS**

Recommended Hardware  
 (8) 11-233 BHCS  
 (8) 11-205 T-nut

Bearing Material - DELRIN  
 Plate Material - Aluminum  
 Finish - Clear Anodize