

EB-22

5/16" SLOTS

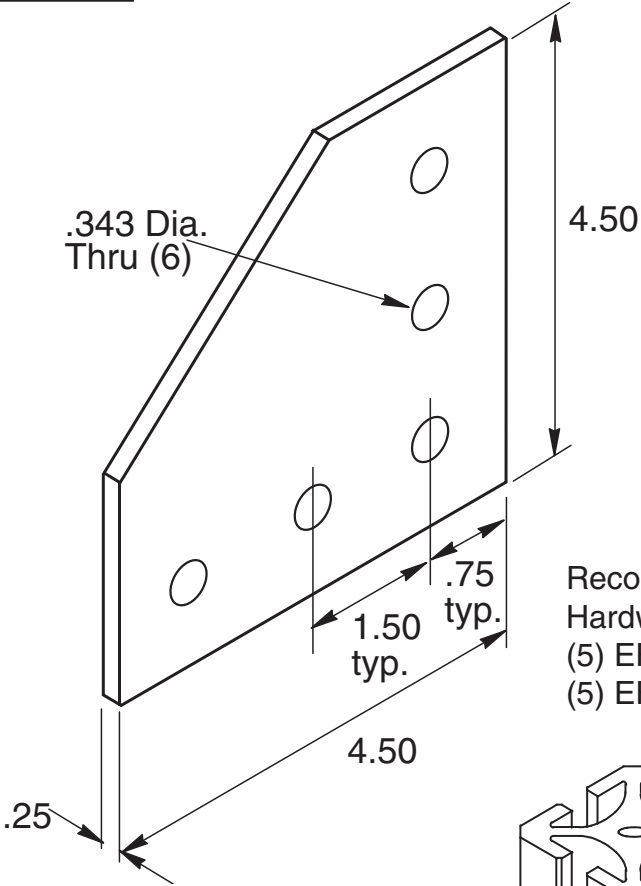

Recommended Hardware
(5) EF-12-.63 BHCS
(5) EF-2 T-nut

Material - Aluminum
Finish - Clear Anodize

