

Recommended
Hardware
(15) EF-12-.63 BHCS
(15) EF-2 T-nut

Material - Aluminum
Finish - Clear Anodize

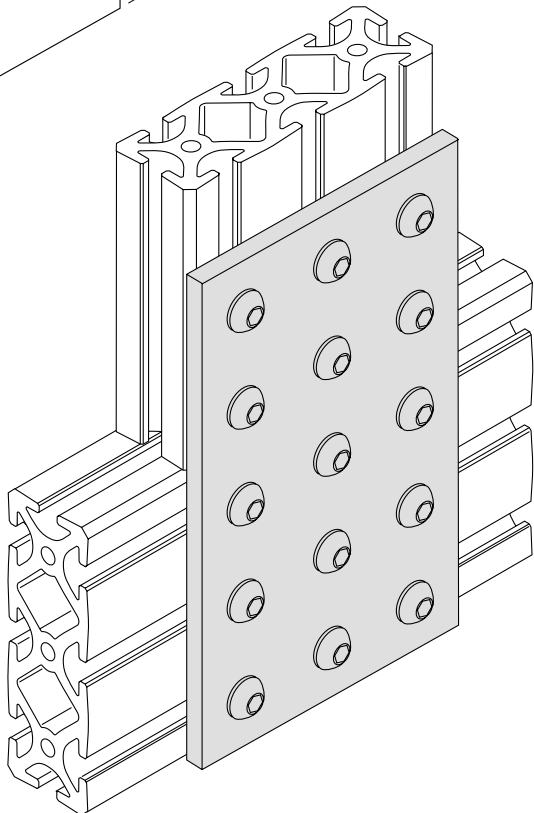

5/16" SLOTS